

Hazards and Safe Operation of

# Pressure and Temperature Instruments in Hydrogen Systems

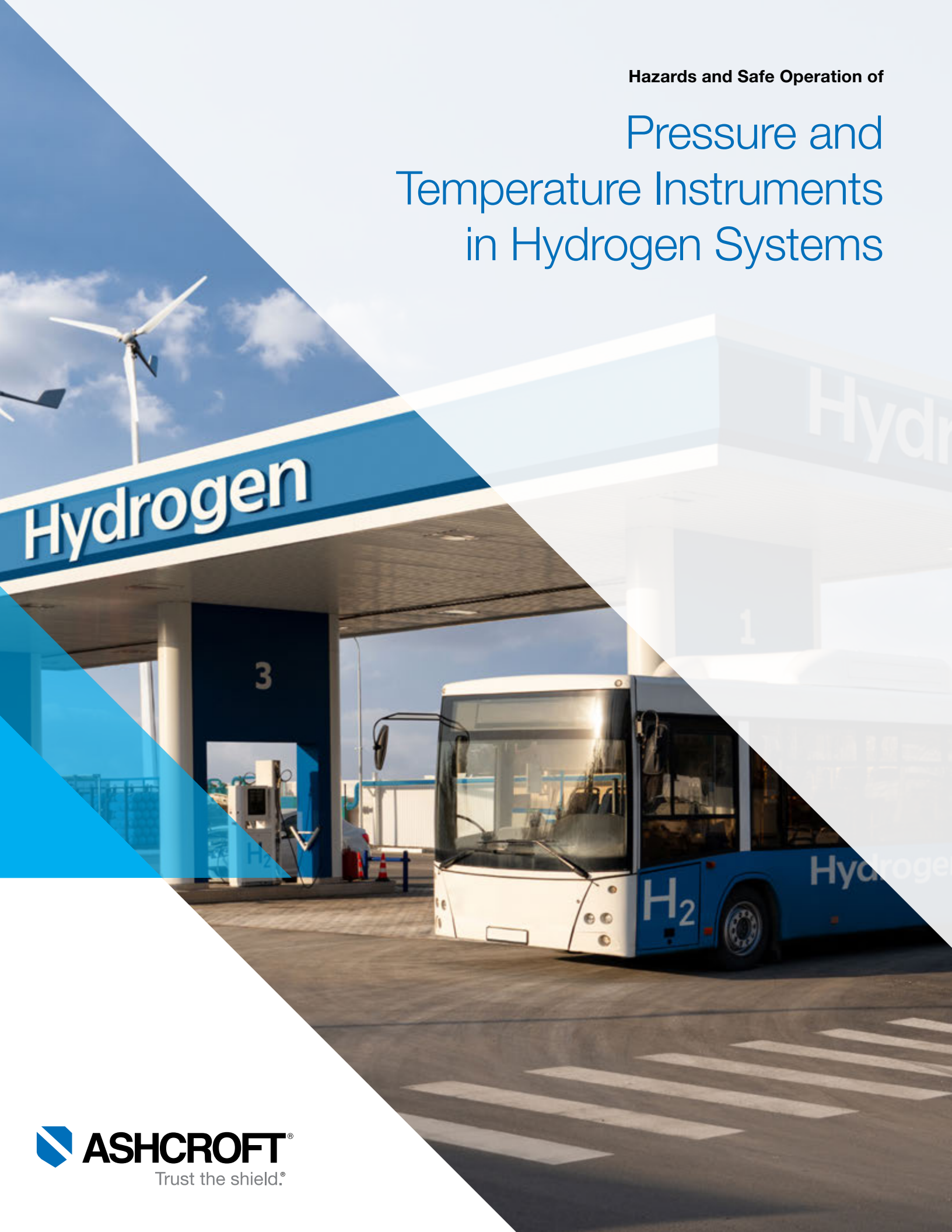

# Welcome to Ashcroft

## Get reliable pressure and temperature solutions for your Hydrogen Systems.

Hydrogen is one of the most useful yet dangerous elements on the atomic chart, but when handled correctly, hydrogen can be put to a variety of good uses. This volatile substance requires an acute understanding of its properties and effects to keep your application running efficiently and safely.

You shouldn't have to be an expert in pressure and temperature instrumentation to get the right components for your applications. You need a partner with expertise in the hydrogen industry who can help you meet instrument quality and safety requirements. Ashcroft has years of experience partnering with customers and offering solutions for their hydrogen applications.

Let us help you navigate the expanding hydrogen market and its demands.

### Contact us to help with your next project:

 1.800.328.8258

 [ashcroft.com](https://www.ashcroft.com)

# Introduction

Hydrogen is the lightest and most abundant element in the universe. In its fundamental form, it is the simplest of all elements, consisting of a single proton and a single electron. It serves as a building block for many things we interact with, consume, and utilize every day, such as water, gasoline, and plastics.

This guide will focus on the properties of hydrogen both in its pure form and in applications in which it is present or created, and how it affects the pressure instrumentation selected and used for these hazardous applications.

## Table of Contents Page



### [Chapter 1: Overview of Hydrogen](#)

4



### [Chapter 2: Hydrogen Hazards](#)

6



### [Chapter 3: Applications for Hydrogen](#)

10



### [Chapter 4: Review of Hazardous Locations](#)

15



### [Chapter 5: Select the Right Instrumentation for Your Hydrogen Service Needs](#)

19

## Chapter 1:

## Overview of Hydrogen

Hydrogen is a naturally occurring element. However, it can also be easily manufactured or created as a byproduct of various processes and (sometimes unintended) phenomena.

In its typical pure and stable form, hydrogen is a colorless and odorless gas that consists of two atoms of hydrogen combined to make a molecule ( $H_2$ ). By compressing and cooling it to below its critical point, it takes on a liquid state.

Hydrogen exhibits slightly different properties, depending on whether it is in a gaseous or liquid state.

## Properties of Gaseous Hydrogen

- In ambient conditions, hydrogen is a gas.
- Hydrogen is the lightest molecule with a standard atomic weight of 1.008.
- Hydrogen is 14 times lighter than air, which allows it to rise at almost 20 meters per second (44 miles per hour) and disperse rapidly. This buoyancy is a built-in safety advantage in an outside environment.
- It is colorless, odorless, tasteless, and undetectable by human senses.
- It is non-toxic and non-poisonous; however, it can be an asphyxiant.
- It is flammable and explosive over a wide range of concentrations, so it should be safely stored and used in an area that is free of heat, flames, and sparks.
- It is non-corrosive, but it can cause embrittlement in some metals (i.e., cause significant deterioration of the metal's mechanical properties).

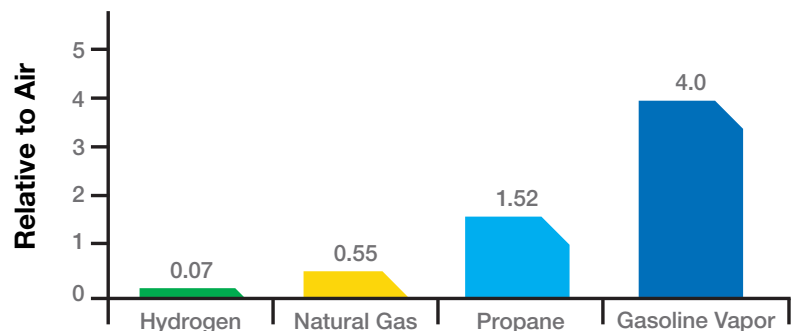
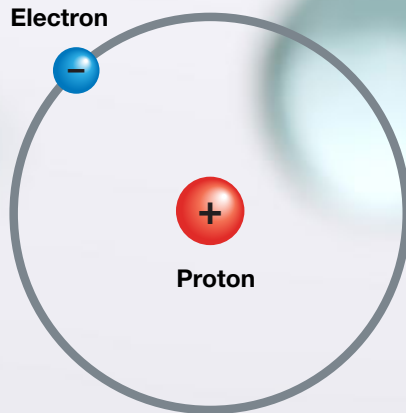

Figure 1. Relative Vapor Density



### Properties of Liquid Hydrogen

- Hydrogen exists as a liquid at -423 °F. Materials stored at this low temperature can cause cryogenic burns or lung damage, so personal protective equipment (PPE) is mandatory.
- Hydrogen undergoes a rapid phase change from liquid to gas, so ventilation and pressure relief devices are built into cryogenic hydrogen systems to ensure safety.
- The volume ratio of liquid to gas is 1:848. If you picture a gallon of liquid hydrogen, that same amount of hydrogen would, theoretically, occupy 848 gallon containers as a gas (without compression).
- Even in dry climates, a liquid hydrogen spill can create a white cloud of condensed water vapor due to the cryogenic temperature affecting the humidity in the surrounding air. This low-temperature water vapor is heavier than air, so the cloud remains localized and may move horizontally. As the hydrogen warms, it dissipates and quickly rises.





## Chapter 2:

# Hydrogen Hazards

Hydrogen has some unique and unusual properties that make it useful in all corners of science and industry. However, there are challenges to working with it safely. Whether it is in its pure state, manufactured, or produced as a byproduct, it must be handled with care.

With liquid hydrogen, leaks are characterized by frost or ice crystals near the leak and usually a vapor cloud indicating moisture condensation from the surrounding air. However, gaseous hydrogen leaks are impossible to detect by human senses since hydrogen is colorless, odorless, and tasteless.

## Hydrogen Explosion

Hydrogen, in sufficient concentrations and quantities, can create overpressure as a result of unignited releases of pressurized gas or an ignited cloud of released flammable gas. In both cases, the overpressure generated can be harmful, causing direct hazards from the overpressure and indirect hazards from building damage or flying debris.

### ■ Overpressure from Unignited Releases

- As with any cryogenic fluid, if liquid hydrogen is warmed and vaporized into a gaseous state, it occupies significantly more space. From its liquid phase to its gas phase, hydrogen expands to about 850 times its size. Therefore, a confining vessel, pipeline, or sealed space could easily become overpressurized during a liquid to gas phase change. If a pressurized gas container is heated, the gas will expand even further. If the pressure exceeds the container design rating, mechanical failure will occur.
- Pressure-relief devices (PRDs), such as rupture disks or relief valves, should be installed to prevent overpressure from occurring. The PRD should be vented to a safe location.

### ■ Overpressure from Ignited Releases

- Beyond overpressure associated with the stored gas, flammable gases like hydrogen can burn. If a cloud of hydrogen gas is ignited, the rapid combustion (i.e. explosion) can create overpressure.
- As with gasoline vapors at a fueling station, certain precautions must be taken to limit the number of ignition sources (such as lit cigarettes or unclassified electrical equipment) in areas where a release of hydrogen could form a hazardous cloud with sufficient concentration to create an ignited overpressure. These areas are often referred to as “exclusion zones” or “separation distances.”

**Some of the ways of detecting gaseous hydrogen leaks include:**



- Listening for high-pressure gas leaking (loud hissing sound)
- Using portable hydrogen detectors
- Installing gas detectors in storage facilities and fueling stations and listening/watching for audible or visual alarms

If left unchecked, both liquid and gaseous hydrogen leaks can cause severe issues, such as asphyxiation, fire, and explosion.

**Hydrogen Flames**

Hydrogen is flammable at concentrations between 4% and 75% in air, which is a very wide range compared to other common fuels, as shown in Figure 2. Under the optimal combustion condition (a 29% hydrogen-to-air volume ratio), the energy required to initiate hydrogen combustion is much lower than that required for other common fuels (e.g., a small spark will ignite it), as shown in Figure 3. However, at low concentrations of hydrogen in air, the energy required to initiate combustion is similar to that of other fuels.

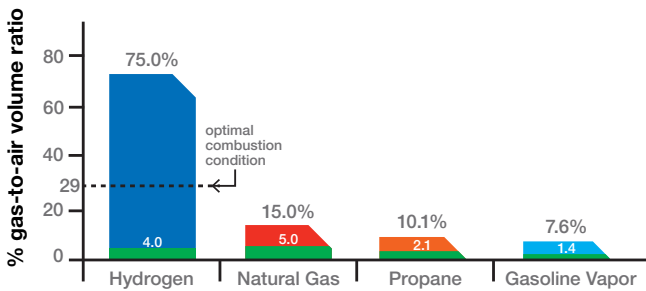

Figure 2: Flammability Range

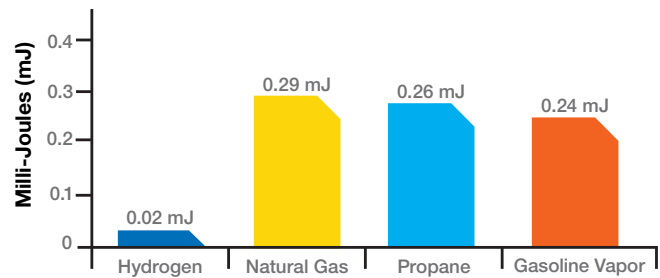

Figure 3: Minimum Ignition Energy

While in an outdoor environment, a hydrogen leak would simply rise quickly and diffuse. Conversely, in a confined space with no ventilation, a leak could easily cause the hydrogen concentration to reach the lower flammability limit (4%). **It is important to note that combustion can't happen in a tank that contains only hydrogen. Oxygen (or air) and an ignition source are required for combustion to occur.**

The auto-ignition temperature of a substance is the lowest temperature at which it will spontaneously ignite without the presence of a flame or spark. The auto-ignition temperatures of hydrogen and natural gas are very similar. Both have auto-ignition temperatures over 1,000 °F, much higher than the auto-ignition temperature of gasoline vapor, as shown in the graph below (Figure 4).

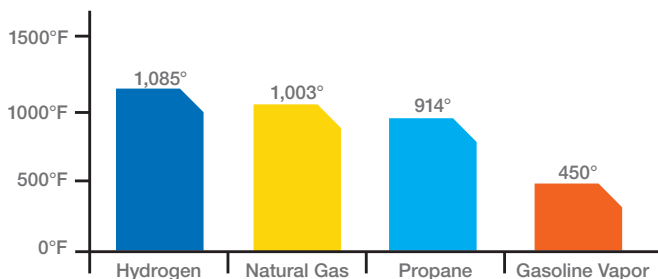

Figure 4: Auto Ignition Temperature

**Two of the main dangers associated with hydrogen flames are:**

- Hydrogen burns with a pale blue flame that is almost invisible during daylight hours, so fires are almost impossible to see with the naked eye.
- The flames have low radiant heat, so you can't sense the presence of a flame until you are very close or in it.

## Hydrogen Embrittlement

Embrittlement is a phenomenon that causes loss of ductility and, consequently, brittleness in a material. Highly susceptible materials include high-strength steels, titanium and aluminum alloys, and electrolytic tough pitch copper.

Hydrogen embrittlement is also known as hydrogen-induced cracking or hydrogen attack. The mechanisms can be aqueous or gaseous and involve the ingress of hydrogen into the metal, reducing its ductility and load-bearing capacity.

Simplified, the cause for embrittlement can be easily explained. Because hydrogen is such a small atom, it can penetrate into the metal through micro flaws in the surface. Once inside, the hydrogen atoms will recombine with others to form hydrogen molecules ( $H_2$ ). These molecules will bond with other  $H_2$  molecules resulting in the bigger hydrogen mass that exerts outward pressure in the flaw. Stress below the yield stress of the susceptible material then causes subsequent cracking and catastrophic brittle failures.

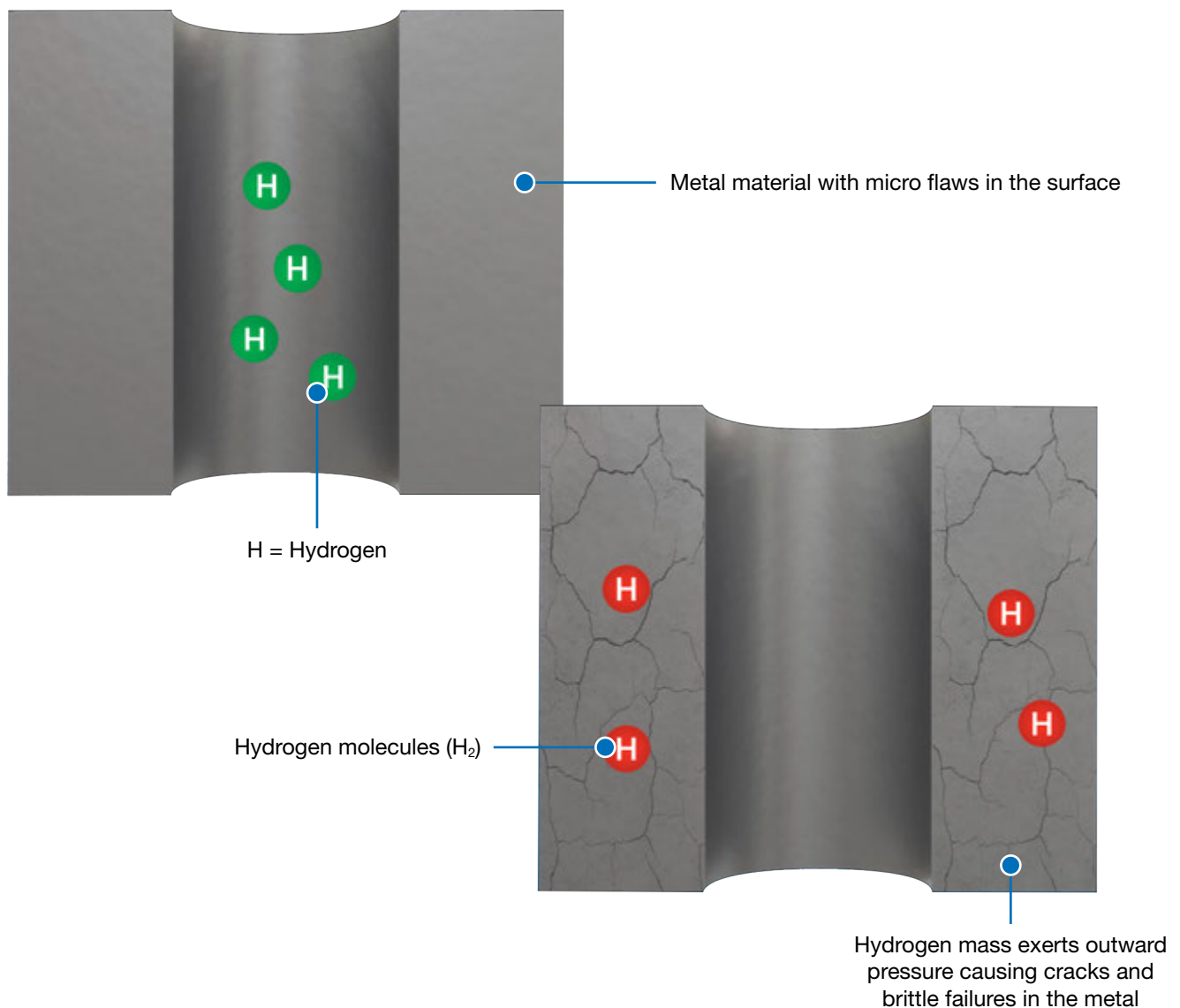



## Hydrogen Permeation

Hydrogen permeation refers to the penetration of hydrogen ions through thin metal diaphragms, such as those found on transducers or diaphragm seals. Over time, this penetration will cause errors in measurement.

If the  $H_2$  molecule splits into  $H^+$  ions with a reduced size, they can push through the diaphragm's metal lattice structure. The  $H^+$  ions will reform in the fill fluid as  $H_2$  molecules and eventually form hydrogen bubbles. These bubbles will cause Zero and Span shifts.

One solution to hydrogen permeation is adding a very thin layer of gold plating to the metal diaphragm. This layer has a very tight lattice structure that increases the diaphragm's resistance to hydrogen permeation.

**Process Fluid**

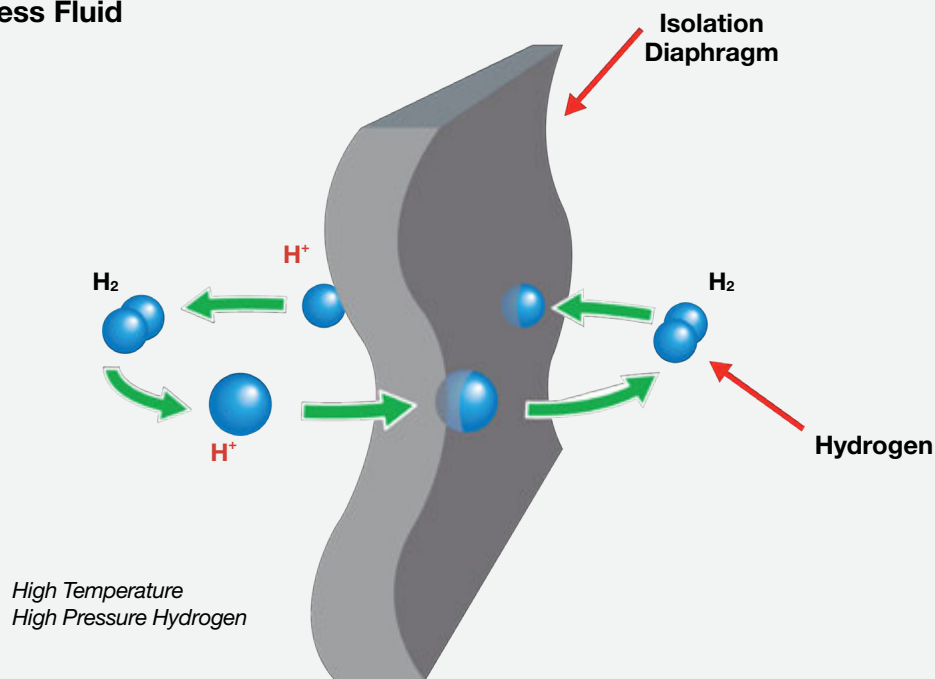

## Hydrogen Asphyxiation

If hydrogen accumulates in a confined space in sufficient concentrations, it serves as an asphyxiant (like any other infiltrating gas that reduces the concentration of oxygen in the surrounding environment).

## CHAPTER 3:

# Applications of Hydrogen

Hydrogen finds use in a wide range of industrial applications and processes, including, but not limited to, the following:



**Power Plant Generator Cooling**



**Petroleum Refining – Hydrocracking**



**Fuel Cells**



**Hydrogen Fueling Stations**



**Glass Manufacturing**



**Semiconductor Manufacturing**



**Aerospace Applications**



**Welding, Annealing, and Heat-Treating Metals**



**Pharmaceuticals**



**Hydrogenation Of Unsaturated Fatty Acids In Vegetable Oil**



**Fertilizer And Ammonia Production**

Ashcroft pressure and temperature measurement instruments are most commonly used in the following applications:



### Power Plant Generator Cooling

Hydrogen is used as coolant in electricity generating equipment. Its relatively low viscosity (gaseous viscosity of 88.05 micropoise) and high heat capacity (constant pressure heat capacity of 3.41 Btu/(lb R)) make it an effective cooling material. It also has a thermal conductivity of 0.17064 Watts/(m K).

Hydrogen can be used in approximately 100% concentration, which means that there is no oxygen present to support combustion. The absence of oxygen in its cooling gas also means the generator's high-voltage insulation system will not be damaged by any corona activity in the generator's stator windings. The localized electric field near a conductor can be sufficiently concentrated to ionize air close to the conductors. This ionized air can create an electrical discharge that has the potential to damage equipment or ignite material.



### Petroleum Refining – Hydrocracking

Hydrocracking is a two-stage process that combines catalytic cracking and hydrogenation. It is used for feedstocks that are difficult to process by either catalytic cracking or reforming. The process employs high pressure, high temperature, a catalyst, and hydrogen to crack the heavier feedstocks and produce more desirable products.

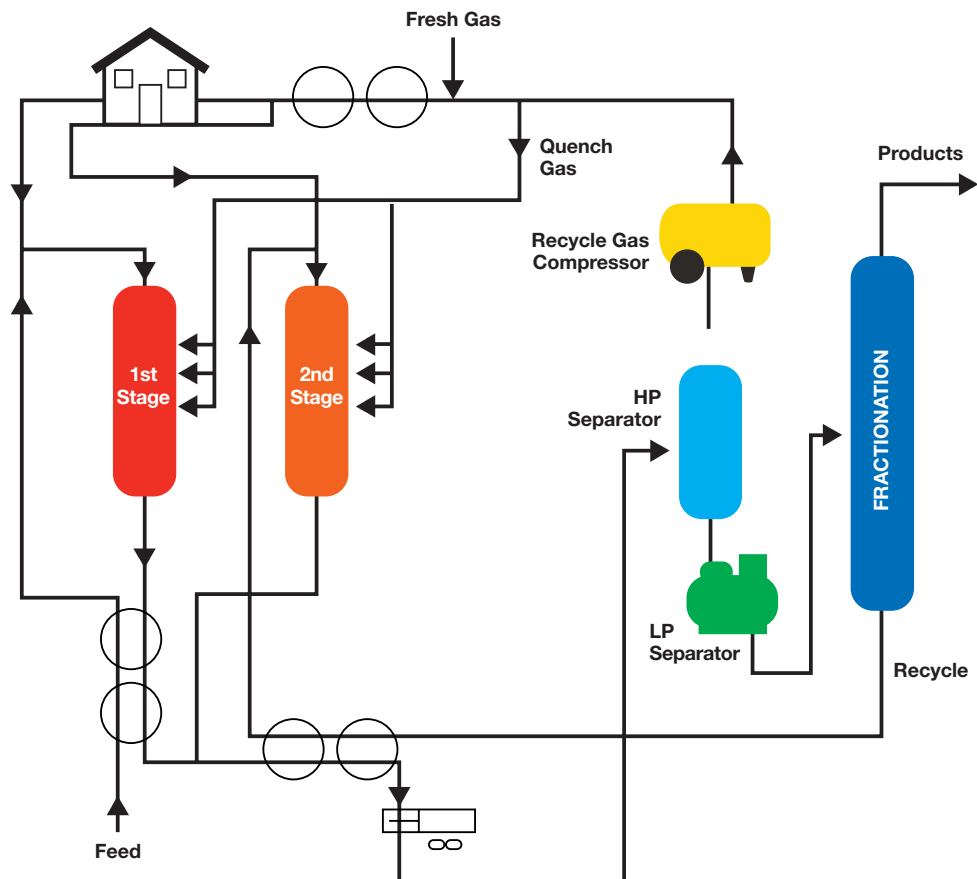

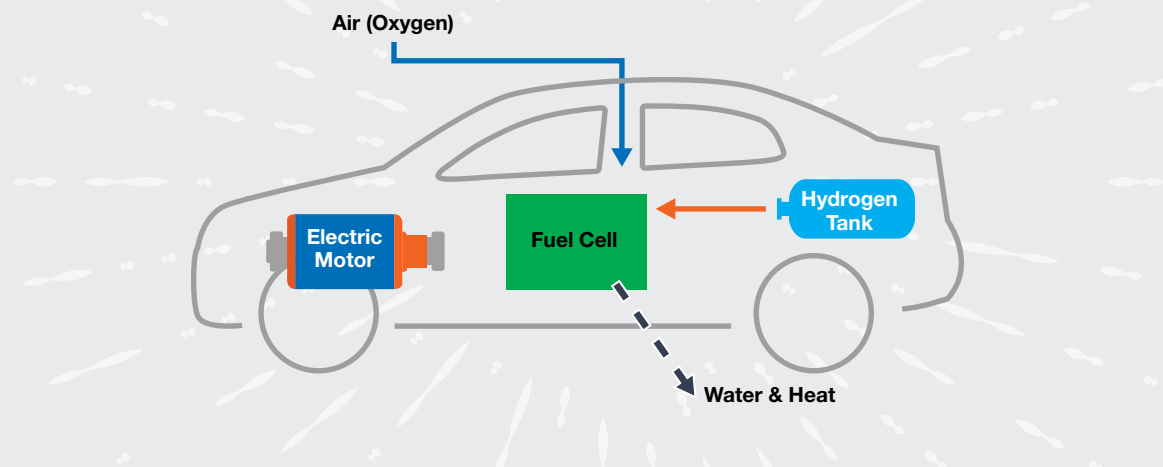

## Fuel Cells

Hydrogen can be converted into electricity using a fuel cell. Hydrogen fuel cells can be used as power sources for electric vehicles or as stationary sources of electricity. They offer many advantages, including no combustion emissions and, in the case of stationary fuel cells, reliable power that can be used in emergency situations (e.g., storms or grid outages).

The basic reaction in a hydrogen-powered fuel cell is illustrated by the following chemical formula:



This reaction typically takes place in the presence of a platinum catalyst. The cost of the catalyst is one of the major factors that determine the overall cost of the fuel cell or cells.

A single fuel cell does not provide sufficient power for most applications, so fuel cells are generally stacked to increase power. Hence, the term “fuel cell stack” is used to describe the fuel cells used in both stationary and vehicular applications.

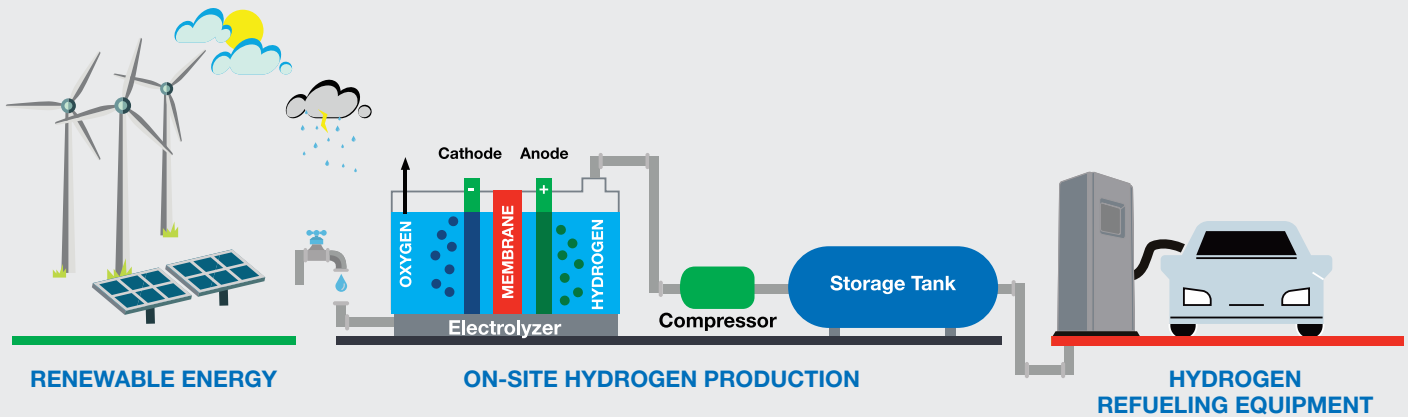

## Hydrogen Fueling Stations

Hydrogen filling stations have two filling pressures: 350 bar (5,000 psi) or 700 bar (10,000 psi). They can fill a fuel cell car with a driving range of ~300 miles in three to five minutes.

### The process of producing fuel for filling stations is as follows:

- Renewable energy is purchased from the utility company.
- The energy is used to split water into pure hydrogen and oxygen.
- The hydrogen is held in a buffer tank, while the oxygen is released into the atmosphere.
- The hydrogen is compressed, and the gas is pumped to storage vessels for delivery to the fuel pump.





### Semiconductor Manufacturing

Hydrogen is utilized in semiconductor manufacturing primarily for its reducing or oxygen scavenging properties. It is also an extremely effective heat transfer fluid, which is an advantageous property in some operations. Some of the semiconductor manufacturing operations in which it is used include:

- Semiconductor sintering
- Semiconductor packaging
- Wafer annealing



### Fertilizer and Ammonia Production

Ammonia and associated compounds are critical for providing nitrogen to crops. The Haber-Bosch process can produce significant amounts of ammonia, including quantities large enough to support large crop production.

The Haber-Bosch process for producing ammonia is illustrated by the following chemical reaction formula:



Hydrogen is a raw feedstock for this reaction. The yield is improved by using an iron catalyst and increasing the reaction pressure.

### What makes a Hazardous Location?

The graphic shown is a classic fire triangle.



To have a fire you need to have all three components: Flammable material (fuel), Air/oxygen and an Ignition source present.

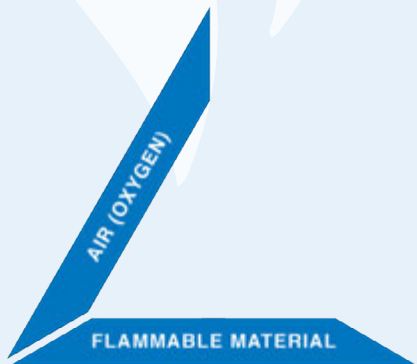

If you remove any one of the components you will not have a fire.

## CHAPTER 4:

# Review of Hazardous Locations

Hazardous locations are areas where there is a possibility or risk of fire or explosion due to the presence of a flammable or explosive atmosphere and/or mixture. Any electrical equipment, such as pressure switches and transducers, used in these hazardous areas must be designed to contain or prevent a fire or explosion from occurring.

### Related Organizations, Authorities, and Testing Labs

Numerous organizations and authorities are involved with ensuring electrical equipment meets hazardous location requirements, including the following:

Type	Description
<b>Standards Organizations</b>	Several organizations provide guidelines regarding the design, construction, and installation of electrical equipment for hazardous locations. For example, the National Fire Protection Association (NFPA) and National Electric Code (NEC) provide standards for United States companies, while the International Electrotechnical Commission (IEC) provides standards applicable to companies around the globe.
<b>Code-Enforcing Authorities</b>	Code-enforcing authorities—i.e., authorities having jurisdiction—are the entities responsible for approving a specific installation. These can include: <ul style="list-style-type: none"> <li>■ Local Inspector</li> <li>■ Insurance underwriter’s representative</li> <li>■ Municipal Authority (Fire Marshal or Electrical Inspector)</li> </ul>
<b>Nationally Recognized Testing Labs (NRTLs)</b>	NRTLs are organizations empowered by OSHA to certify compliance to recognized standards. Notified Bodies are similar to NRTLs, but they certify to the IEC standards (ATEX, IECEx). Examples include: <ul style="list-style-type: none"> <li>■ Underwriter’s Laboratories (UL)</li> <li>■ Factory Mutual Research Corporation (FM)</li> <li>■ Canadian Standards Association (CSA)</li> <li>■ SIRA (ATEX, IECEx)</li> </ul>

### Hazardous Area Classifications

Hazardous areas can be classified using two systems: Class/Division/Group or Zone. Companies in the United States and Canada primarily use the Class/Division/Group system, while companies in the rest of the world use the Zone system.

**Class/Division/  
Group System –  
NEC 500:**

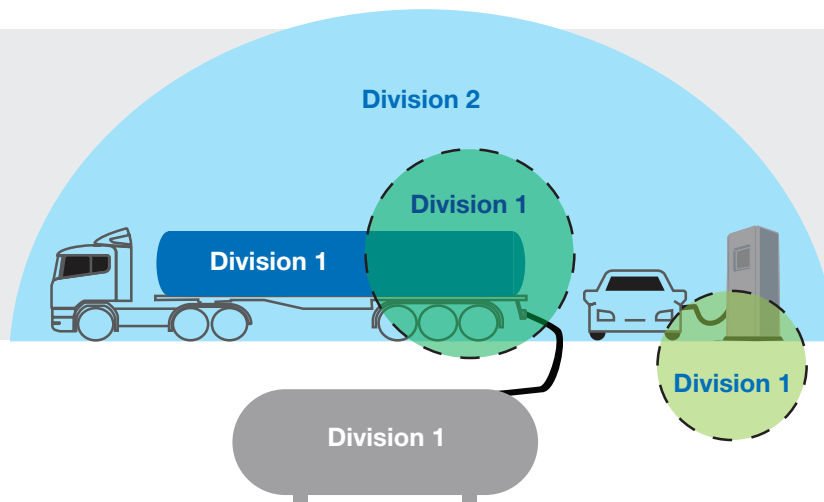

Class	Type of Fuel
Class I	Flammable gases or vapors
Class II	Combustible Dust
Class III	Fibers

Division	Possibility of Fuel Being Present
Division I	Present or likely to be present in normal operation
Division II	Not present in normal operation, could be present in abnormal operation

Group	Specific Type of Fuel
Group A	Acetylene
Group B	Hydrogen
Group C	Acetaldehyde, Ethylene, Methyl Ether
Group D	Acetone, Gasoline, Methanol, Propane
Group E	Metal Dust
Group F	Carbon Dust
Group G	Grain Dust

Code	Max Surface Temperature	Code	Max Surface Temperature
T1	450 °C	T3A	180 °C
T2	300 °C	T3B	165 °C
T2A	280 °C	T3C	160 °C
T2B	260 °C	T4	135 °C
T2C	230 °C	T4A	120 °C
T2D	215 °C	T5	100 °C
T3	200 °C	T6	85 °C



**Class/Division/Group System and Zone System Comparison:**

IEC Apparatus Protection Type	
Zone 0	Intrinsic Safety "ia"
Zone 1	Intrinsic Safety "ia" & "ib" Flameproof (explosion proof) Enclosure "d" Increased Safety "e" Pressurized Apparatus "p" Encapsulation "m"
Zone 2	All equipment certified for Zone 0 or Zone 1 Increased Safety (Nonincendive) Circuit

North America Apparatus Protection Type	
Class 1, Division 1	Intrinsic Safety Explosion Proof Enclosure Pressurization
Class 1, Division 2	All equipment certified for Division 1 Nonincendive

**Zone System –  
NEC505, ATEX,  
IECEX, INMETRO:**

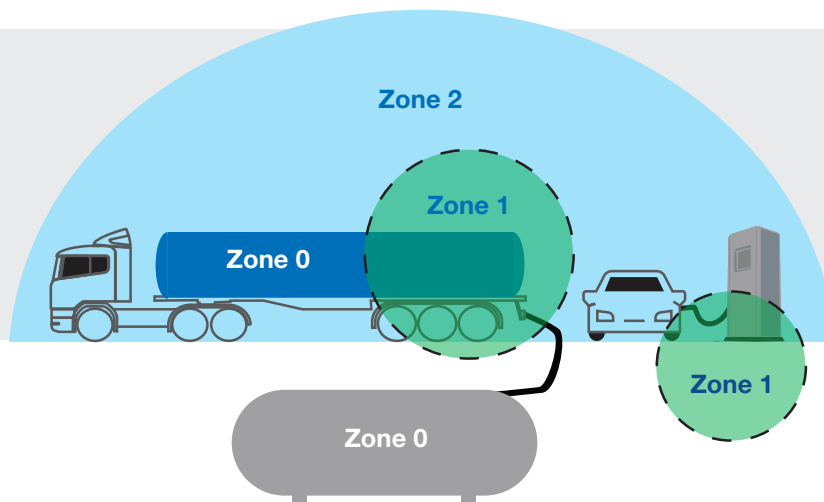

Zone	Possibility of Fuel Being Present
Zone 0	Explosive gas-air mixture is continuously present
Zone 1	Explosive gas-air mixture is likely to occur
Zone 2	Explosive gas-air mixture is not likely to occur

Group	Specific Type of Fuel
Group I	Methane, Coal Dust
Group IIA	Propane
Group IIB	Ethylene
Group IIC	Hydrogen, Acetylene

Type	Protection Method	Zone Used In
d	Flameproof (explosion proof) Enclosure	1, 2
e	Increased Safety	1, 2
ia	Intrinsic Safety	0,1, 2
ib	Intrinsic Safety	1, 2
o	Oil Immersion	2
p	Pressurized Apparatus	1, 2
q	Power Filling	2
m	Encapsulation	1, 2

Code	Max Surface Temperature
T1	450 °C
T2	300 °C
T3	200 °C
T4	135 °C
T5	100 °C
T6	85 °C



### Equipment Classifications for Hazardous Locations

Electrical equipment can receive several classifications depending on its design and construction:

- **Explosion-Proof/Flame-Proof:** Explosion-proof or flame-proof means the equipment can contain a defined explosion. This is achieved by the inclusion of a defined flame path. For example, a minimum of seven threads engaged on a switch case cover and conduit connection.
- **Intrinsically Safe:** Intrinsically safe means the equipment limits energy to prevent an explosion by using an approved barrier.
- **Non-Incendive or Non-Sparking:** Non-incendive/non-sparking means the equipment limits energy to prevent an explosion without using a barrier. It is suitable for use in Division 2 or Zone 2 only. Installations require the use of non-incendive field wiring concepts.
- **Simple Apparatus:** Simple apparatus means the equipment cannot generate or store energy. One example is a micro switch. It can be used with a barrier as long as the barrier is approved for use with a simple apparatus.

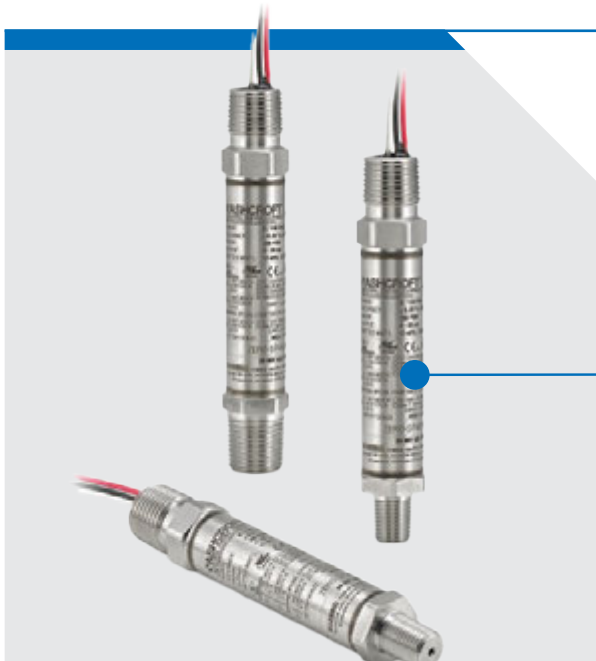

### Importance of Equipment Labeling

All equipment being used must be able to meet the specific class/division/group or zone requirements and be clearly marked with its ratings.



CHAPTER 5:

# Select the Right Instrumentation for Your Hydrogen Service Needs

At Ashcroft, we are dedicated to helping customers identify the right instruments for their projects. Whether your hydrogen service application is in the aerospace, glass manufacturing, oil and gas, or another industry, you can trust in us to provide you with a reliable, accurate and safe instrumentation solution. Our experts recommend the following pressure instruments for hydrogen service.

Note: For most products, Oxygen cleaning is available if required for your application.

## Pressure Switches for Hydrogen Service



		A-Series Explosion Proof	B-Series NEMA 7/9 Explosion Proof Pressure Switch
<b>Model</b>		<b><u>APSN7 or APAN7</u></b>	<b><u>B700</u></b>
<b>Specifications</b>	Enclosure	Explosion Proof	Explosion Proof
	Wetted Materials	With S Actuator 316L Stainless Steel	With S Actuator 316L Stainless Steel
<b>Ranges</b>	Pressure	Vacuum to 200 psi	0-15 to 0-1,000 psi
<b>Approvals</b>		CE, UKCA, CRN, 3A, FM, UL, CSA, ATEX, IECEx and RoHS compliant	CE, UKCA, FM, UL, CSA, ATEX, IECEx and RoHS compliant



		F-Series NEMA 7 Explosion Proof Pressure Switch	P-Series NEMA 7/9 Explosion Proof Pressure Switch
<b>Model</b>		<b><u>F-Series</u></b>	<b><u>P-Series</u></b>
<b>Specifications</b>	Enclosure	Explosion Proof	Explosion Proof
	Wetted Materials	With S Actuator 316L Stainless Steel	With S Actuator 316L Stainless Steel
<b>Ranges</b>	Pressure	0-30 to 0-1,000 psi	0-15 to 0-1,000
<b>Approvals</b>		UL, CSA, CE, UKCA	CE, UKCA, CRN, UL, CSA

Access datasheets at [ashcroft.com](http://ashcroft.com) for complete product specifications.

## Transducers and Transmitters for Hydrogen Service

Transducers with all 316L or A286 wetted materials, such as:



		E2 Intrinsically Safe/Non-Incendive Pressure Transducer	E2 Explosion Proof Transducer
<b>Model</b>		<b>E2S</b>	<b>E2F/E2X</b>
<b>Specifications</b>	Accuracy	±0.25%, ±0.50% or ±1.0% of span	±0.25%, ±0.50% or ±1.0% of span
	Output	4-20 mA, 0-5 Vdc, 1-5 Vdc, 0-10 Vdc, 1-11 Vdc, 0.1-5 Vdc, 0.1-10 Vdc, 0.5-4.5 Vdc	4-20 mA, 0-5 Vdc, 1-5 Vdc, 0-10 Vdc, 1-11 Vdc, 0.1-5 Vdc, 0.1-10 Vdc, 0.5-4.5 Vdc
<b>Ranges</b>	Pressure	Vacuum to 20,000 psi	Vacuum to 20,000 psi
	Operating Temperature	-40 °F to 176 °F -40 °C to 80 °C	-40 °F to 176 °F -40 °C to 80 °C
<b>Approvals</b>		Intrinsically Safe - FM, CSA, ATEX, IECEx Non-incendive - FM CE, UKCA, RoHS Compliant	E2F/E2X - Flameproof/Explosion Proof - FM, CSA, ATEX, IECEx E2X - Intrinsically Safe - FM, CSA, ATEX, IECEx E2X - Non-Incendive - FM CE, UKCA, RoHS Compliant



		ZT12 High Purity Pressure Transmitter	High Purity Non-Sparking Pressure Transmitter	ZT16 High Purity Pressure Transmitter
<b>Model</b>		<b>ZT12</b>	<b>ZX12</b>	<b>ZT16</b>
<b>Specifications</b>	Accuracy	±0.25% of span	±0.25% of span	±0.50% or ±1.0% of span
	Output	4-20 mA	4-20 mA	4-20 mA, 1-5 Vdc
<b>Ranges</b>	Pressure	Vacuum to 3,000 psi	Vacuum to 3,000 psi	Vacuum to 150 psi
	Operating Temperature	-4 °F to 158 °F -20 °C to 70 °C	-4 °F to 158 °F -20 °C to 70 °C	-4 °F to 158 °F -20 °C to 70 °C
<b>Approvals</b>		CE, UKCA and RoHS compliant	Increased Safety - ATEX, IECEx CE, UKCA and RoHS Compliant	CE, UKCA and RoHS compliant

Access datasheets at [ashcroft.com](http://ashcroft.com) for complete product specifications.

## Pressure Gauges for Hydrogen Service

Pressure gauges should have all-welded 316L stainless steel tubes and sockets. In Europe, the gauges may require ATEX approval.



		Stainless Steel Case Gauge (open front/ Solid Front, ASME/ EN837-1)	Stainless Steel Case Gauge, Removable Bayonet Ring	Compact Stainless Steel Case Gauges (open front, ASME)
<b>Model</b>		<b>8008S</b>	<b>8009S</b>	<b>1008S</b>
<b>Specifications</b>	Accuracy	±1% & ±1.6% of span per EN837-1 ±2-1-2% of span ASME B40.100	±1% & ±1.6% of span per EN837-1 ±2-1-2% of span ASME B40.100	±3-2-3% of span (ASME B40.100 Grade B)
	Sizes	Solid Front 63 mm Open Front 63 & 100 mm	63 & 100 mm	40 & 50 mm
<b>Ranges</b>	Pressure	Vacuum, Compound, 15 to 20,000 psi	Vacuum, Compound, 15 to 20,000 psi	Vacuum, Compound, 15 to 20,000 psi



		Thermoset & Thermoplastic Case Gauges with Thermoplastic Ring & Back Cover (solid front, ASME B40.100)	Stainless Steel Case, Ring & Back Cover Gauges (open front or solid front, EN 837-1)	Stainless Steel Case, Ring & Back Cover Gauges (solid front, ASME B40.100)
<b>Model</b>		<b><u>1279 with 316L Stainless steel wetted material, 1259</u></b>	<b><u>T5500, T6500</u></b>	<b><u>1209</u></b>
<b>Specifications</b>	Accuracy	±0.5% of span (ASME B40.100 Grade 2A)	±1% of span (EN 837-1)	±0.5% of span (ASME B40.100 Grade 2A)
	Sizes	4½"	100 mm or 160 mm	4½"
<b>Ranges</b>	Pressure	Vacuum, Compound, 15 to 20,000 psi	Vacuum, Compound, 15 to 20,000 psi	Vacuum, Compound, 15 to 20,000 psi

Access datasheets at [ashcroft.com](http://ashcroft.com) for complete product specifications.

## Diaphragm Seals for Hydrogen Service

Diaphragm seals can be used to protect instruments with wetted materials that are not suited for use with hydrogen. We recommend using gold-plated 316L Stainless steel diaphragms, which are available in the 100 series diaphragm seals and the DF Flush Flanged diaphragm seals.



		Flush Flanged Diaphragm Seals	Threaded Diaphragm Seals	Flanged Diaphragm Seals
<b>Model</b>		<b>DF</b>	<b>100</b>	<b>102</b>
<b>Specifications</b>	Diaphragm Material	316L Stainless Steel or Gold-plated 316L Stainless Steel	316L Stainless Steel or Gold-plated 316L Stainless Steel	3316L Stainless Steel or Gold-plated 316L Stainless Steel
	Bottom Housing Material	Flush designs eliminates the need for a bottom housing	316L Stainless Steel	316L Stainless Steel
<b>Ranges</b>	Pressure Ratings	150 to 2,500 class ASME flanges	500, 2,500 and 5,000 psi	150 to 1,500 class ASME flanges



		All-Welded Seals, Threaded, Flanged	All-Welded Seals, Threaded	All-Welded Seals, Threaded
<b>Model</b>		<b>310</b>	<b>400</b>	<b>510, 511</b>
<b>Specifications</b>	Diaphragm Material	316L Stainless Steel	316L Stainless Steel	316L Stainless Steels
	Bottom Housing Material	316L Stainless Steel	316L Stainless Steel	316L Stainless Steel
<b>Ranges</b>	Pressure Ratings	2,500 psi	4,400 psi, 150-2,500 class ASME flanges	1,500 psi (10,000 psi optional)

## Temperature Sensors



		S50 & S81 RTD Probes	S50 & S80 Thermocouple Probes
<b>Model</b>		Pt 100 Pt 1000	Type J Type E Type K Type N Type T
<b>Specifications</b>	Accuracy	Class A Class B	Class 1 Class 2 Class 3 Standard Special
	Stem Lengths	2" to 120"	2" to 120"
<b>Ranges</b>	Temperature	Pt 100 -200 to 600 °C Pt 1000 -40 to 600 °C	Type J -40 to 750 °C Type E -200 to 800 °C Type K -200 to 1000 °C Type N -200 to 1000 °C Type T -250 to 350 °C

Access datasheets at [ashcroft.com](http://ashcroft.com) for complete product specifications.

## Thermowells



Model		Thermowell <b>Flanged</b>	Thermowell <b>Threaded</b>	Thermowell <b>Sanitary</b>
<b>Specifications</b>	Process Connection	1", 1.5", 2", 3", & 4" Pipe Size	½, ¾, 1 NPT	1", 1.5", & 2" Tri-Clamp
	Overall Length	Min U dimension 2"	Min U dimension 1"	Min U dimension 1"
	Materials	316L Stainless Steel	316L Stainless Steel	316L Stainless Steel



Model		Thermowell <b>Socket Weld</b>	Thermowell <b>Weld-In</b>	Thermowell <b>Van Stone</b>
<b>Specifications</b>	Process Connection	¾" & 1" Pipe Size	1.5" Pipe Size	1", 1.5", 2", 3", & 4" Pipe Size
	Overall Length	Min U dimension 1"	Min U dimension 1"	Min U dimension 2"
	Materials	316L Stainless Steel	316L Stainless Steel	316L Stainless Steel

Access datasheets at [ashcroft.com](http://ashcroft.com) for complete product specifications.

If you have additional questions about instrumentation for hydrogen service applications or would like to discuss your unique requirements with one of our experts, please contact us today!

**Contact us to help with your next project:**

 1.800.328.8258

 [ashcroft.com](http://ashcroft.com)

Learn more about hydrogen applications  
and associated Ashcroft instrumentation  
by visiting our website:

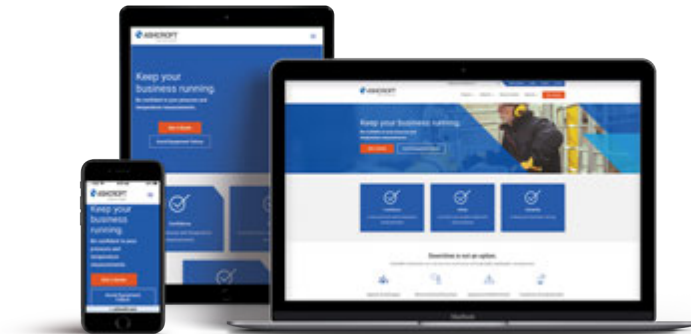

[ashcroft.com](https://www.ashcroft.com) 

### Learn More: Hydrogen related blog articles:

- [Choosing a Pressure Gauge for Hydrogen Applications](#)
- [How are Pressure Transducers Affected by Hydrogen Permeation?](#)
- [Class and Division Codes on Explosion-Proof Pressure Switches](#)
- [Choosing the Right Pressure Sensor: 5 Factors to Consider](#)
- [How Much Do Pressure Transducers Cost? \(6 Factors Impacting Price\)](#)
- [Product Review: 8009S Pressure Gauge with Removable Bayonet Ring](#)
- [Product Review: 8008S Stainless Steel Pressure Gauge](#)
- [Choosing Pressure Transducers for Hydrogen and Hazardous Locations](#)
- [What are Safe Temperature Sensors for Hydrogen Applications?](#)



Visit our blog by  
scanning the QR Code

### Resource Acknowledgements

**H2 Tools** a Hydrogen information resource website intended for public use. It was built, and is maintained, by the Pacific Northwest National Laboratory with funding from the DOE Office of Energy Efficiency and Renewable Energy's Hydrogen and Fuel Cell Technologies Office.